

**DIN**

**EN 12897**  
**EnEV 730.02**  
**ErP 812/2013**  
**ErP 814/2013**  
**DIN 4753**

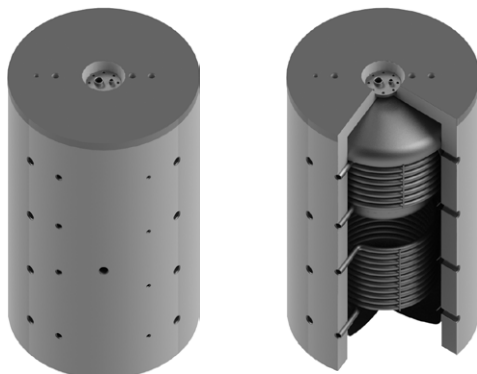

**Bauart**  
**Design | Structure | Struttura**

Die Speicher werden aus hochwertigem Stahl nach EN 10025:2019 gefertigt.  
 Die Speicher werden nach EN 12897:2020 dimensioniert, gefertigt und zertifiziert.

**EN** The storage tanks are made from high quality steel in accordance with EN 10025:2019.  
 The storage tanks are designed, manufactured and certified in accordance with EN 12897:2020.

**FR** Les ballons sont fabriqués en acier de grande qualité selon la norme EN 10025:2019.  
 Les ballons sont dimensionnés, fabriqués et certifiés selon la norme EN 12897:2020.

**IT** Gli accumulatori sono realizzati in acciaio pregiato secondo la norma EN 10025:2019.  
 Gli accumulatori sono dimensionati, costruiti e certificati secondo la norma EN 12897:2020.

<b>Trinkwasserspeicher</b> Domestic hot water tank   Ballon eau chaud sanitaire   Bollitore acqua calda sanitaria	
<b>Betriebsdruck / Prüfdruck</b> Operating pressure / test pressure   Pression de service / Pression test   Pressione d'esercizio / Pressione di collaudo	6 bar / 12 bar
<b>Einsatzgebiet</b> Application   Application   Applicazione	max. 95°C ≥ 6°dH ≥ 11°FH
<b>Pufferspeicher</b> Buffer storage tanks   Ballon tampon   Accumulatori tampone	
<b>Betriebsdruck / Prüfdruck</b> Operating pressure / test pressure   Pression de service / Pression test   Pressione d'esercizio / Pressione di collaudo	3 bar / 4.5 bar
<b>Einsatzgebiet</b> Application   Application   Applicazione	18°C – 95°C

**Lieferumfang**  
**Delivery | Livraison | Consegna**

	Dimension Dimension Dimensione	Art.Nr.	600	800	1000	1500
<b>Thermometer (Messing)</b> Thermometer (Brass)   Thermomètre (Laiton)   Termometro (Ottone)	100 mm	6001150100	1x	1x	1x	1x
<b>Tauchhülse (Messing)</b> Thermowell (Brass)   Doigt de gant (Laiton)   Sonda a immersione (Ottone)	500 mm	6001180500	1x	1x	1x	1x
<b>Magnesium Schutzanode</b> Magne- sium protection anode   Anode de protection en magnésium   Anodo protettivo di magnesio	520 mm	6001140520	1x	1x	1x	1x

## Schutz vor Korrosion

### Anti-corrosion protection | Protection contre la corrosion | Protezione anticorrosiva

Emallierung nach DIN 4753. Magnesium Schutzanode nach DIN 4753-3. Die Pufferspeicher sind innen unbehandelt. Speicher mit separater Isolierung sind aussen grundiert.

**EN** Enamelling in accordance with DIN 4753. Magnesium protection anode in accordance with DIN 4753-3. The storage tanks are untreated on the interior. Tanks with separate insulation are primed on the outside.

**FR** Émaillage conforme à la norme DIN 4753. Anode de protection en magnésium conforme à la norme DIN 4753-3. À l'intérieur, les réservoirs ne sont pas traités. Les réservoirs avec isolation séparée sont apprêtés à l'extérieur.

**IT** Smaltatura secondo DIN 4753. Anodo protettivo di magnesio secondo DIN 4753-3. L'interno degli accumulatori non è trattato. Gli accumulatori con isolamento separato vengono primerizzati all'esterno.

## Wärmetauscher

### Heat exchanger | Échangeur de chaleur | Scambiatore di calore

Die Oberfläche des Trinkwasserspeichers dient als Wärmetauscher. Zwei eingeschweisste grossflächige Wärmetauscher.

**EN** The surface of the domestic hot water storage tank acts as a heat exchanger. Two welded large-surface heat exchangers.

**FR** La surface du ballon d'eau sanitaire placé à l'intérieur fait office d'échangeur de chaleur. Deux échangeurs de chaleur grande surface soudés.

**IT** La superficie dell'accumulatore d'acqua potabile funge da scambiatore di calore. Due scambiatori di calore di grande superficie saldati.

<b>Betriebsdruck / Prüfdruck</b> Operating pressure / test pressure   Pression de service / Pression test   Pressione d'esercizio / Pressione di collaudo	6 bar / 12 bar
<b>Einsatzgebiet</b> Application   Application   Applicazione	max. 110°C

## Isolierung

### Insulation | Isolation | Isolamento

#### TopShell

Isolierung aus Hightech Faservlies. Skaimantel mit Reissverschluss, inklusive Rosetten und Abdeckhaube. Brandschutzklasse B2. Silber. Lose geliefert.

#### Variante

Isolierung aus Hightech Faservlies. PS-Mantel und Hakenleiste, inklusive Rosetten und Abdeckhaube. Brandschutzklasse B2. Farbe Silber.

#### EN TopShell

Insulation made of high-tech fibre fleece. Skai jacket with zip, including cover plates and hood. Fire-resistance rating B2. Silver. Supplied loose.

#### FR TopShell

Isolation en tissu fibreux high-tech Enveloppe en skai avec fermeture à glissière, y compris rosettes et capot. Classe allemande de protection incendie B2. Argent. Livrée non montée.

#### IT TopShell

Isolamento in tessuto non tessuto high-tech. Mantello in skai pre-assemblato con cerniera, dotato di rosette e calotta di copertura. Classe di resistenza antincendio B2. Argento. Consegna sfusa.

#### Alternative

Insulation made of high-tech fibre fleece. PS jacket and hook rack, including cover plates and hood. Fire-resistance rating B2. Silver.

#### Alternative

Isolation en tissu fibreux high-tech Enveloppe en PS équipée d'un support à crochets préinstallé, y compris rosettes et capot. Classe allemande de protection incendie B2. Couleur argent.

#### Alternativa

Isolamento in tessuto non tessuto high-tech. Mantello in PS e barra con ganci, rosette e calotta di copertura incluse. Classe di resistenza antincendio B2. Colore argento.

TopShell  
B2;  $\lambda = 0.038 \text{ W/(mK)}$

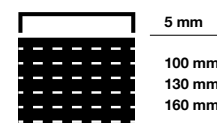

**Kombispeicher**  
**Combination storage tanks**  
**Ballon mixte**  
**Serbatoi di accumulo combinati**  
**PBNRR/E 600 – 1500**

Verwendung Usage   Utilisation   Uso		600	800	1000	1250	1500		
TopShell 100	Wärmeverlust Heat losses Pertesthermiques Perdita di calore	kWh/24h	2.89	3.12	3.38	3.82	-	
		W	121	130	141	160	-	
	ErP-Label ErP class   Classe ErP   Classe ErP	C	C	C	C	-		
	CH   SIA 384/1 Ta ≤ 90°C	•	•	•	•	X		
	EU   Nr. 814/2013 (EU)	•	•	•	•	X		
	A $\downarrow$ [mm]	1700	1740	2090	2060	2200		
	C Ø [mm]	900	990	990	1150	1200		
	Art. Nr. 300112... Part no.   Réf.   Art.n.	0601	0801	1001	1251	1501*		
	TopShell 130	Wärmeverlust Heat losses Pertesthermiques Perdita di calore	kWh/24h	-	-	-	-	4.00
			W	-	-	-	-	167
ErP-Label ErP class   Classe ErP   Classe ErP		-	-	-	-	C		
CH   SIA 384/1 Ta ≤ 90°C		•	•	•	•	•		
EU   Nr. 814/2013 (EU)		•	•	•	•	•		
A $\downarrow$ [mm]		1730	1770	2120	2090	2230		
C Ø [mm]		960	1050	1050	1210	1260		
Art. Nr. 300112... Part no.   Réf.   Art.n.		0602*	0802*	1002*	1252*	1502		
TopShell 160		Wärmeverlust Heat losses Pertesthermiques Perdita di calore	kWh/24h	-	-	-	-	-
			W	-	-	-	-	-
	ErP-Label ErP class   Classe ErP   Classe ErP	-	-	-	-	-		
	CH   SIA 384/1 Ta ≤ 90°C	•	•	•	•	•		
	EU   Nr. 814/2013 (EU)	•	•	•	•	•		
	A $\downarrow$ [mm]	1760	1800	2150	2120	2260		
	C Ø [mm]	1020	1110	1110	1270	1320		
	Art. Nr. 300112... Part no.   Réf.   Art.n.	0603*	0803*	1003*	1253*	1503*		

Ta = Auslegungstemperatur

Ta = dimensioning temperature | Ta = température de conception | Ta = temperatura di progetto

\* Keine Lagerware. Lieferzeit 4–6 Wochen

Not in stock. | Marchandise non stockée. | Merce non a magazzino.

Nicht zugelassen | None approved | Non agréée | Non omologato

Zugelassen (Empfohlene Isolierung)  
Approved (Recommended insulation) | Agréée (Isolation recommandée) | Omologato (Isolamento consigliato)

Zugelassen (oberhalb Mindestanforderung)  
Approved (Exceeds minimum requirements) | Agréée (Supérieure aux exigences minimales requises) | Omologato (Requisito minimo superiore)

**Kombispeicher**  
**Combination storage tanks**  
**Ballon mixte**  
**Serbatoi di accumulo combinati**  
**PBNRR/E 600 – 1500**

Typ PBNRR/E		600	800	1000	1500
<b>Inhalt Heizwasser</b> Hot water capacity   Contenance de l'eau de chauffage   Contenuto acqua calda	l	381	478	632	1200
<b>Inhalt Brauchwasser</b> Service water capacity   Contenance de l'eau sanitaire   Contenuto acqua per uso domestico	l	150	204	204	247
<b>Höhe ohne Isolierung</b> Height without insulation   Hauteur sans isolation   Altezza senza isolamento	mm	1670	1705	2060	2175
<b>Ø ohne Isolierung</b> without insulation   sans isolation   senza isolamento	mm	700	790	790	1000
<b>Kippmass</b> Tilted dimension   Cote de basculement   Altezza in raddrizzamento	mm	1700	1740	2090	2210
<b>Einbringmass</b> Delivery dimensions   Cote de mise en place   Ingombro	mm	730	800	800	1000
<b>Betriebsdruck Heizung</b> Heating operating pressure   Pression de service du chauffage   Pressione d'esercizio riscaldamento	bar	3	3	3	3
<b>Prüfdruck Heizung</b> Heating test pressure   Pression test du chauffage   Pressione di collaudo riscaldamento	bar	4.5	4.5	4.5	4.5
<b>Betriebsdruck Trinkwasserspeicher</b> Domestic hot water tank operating pressure   Pression de service de la ballon ECS   Pressione d'esercizio bollitore	bar	6	6	6	6
<b>Prüfdruck Trinkwasserspeicher</b> Domestic hot water tank test pressure   Pression test de la ballon ECS   Pressione di collaudo bollitore	bar	12	12	12	12
<b>max. Betriebstemperatur</b> max. operating temperature   Temp. de service max.   Temperatura max. d'esercizio	°C	95	95	95	95
<b>Gewicht</b> Weight   Poids   Peso	kg	184	218	258	332
<b>Art.Nr.</b> 200203... Part no.   Réf.   Art.n.		0600	0800	1000	1500
<b>Isolierung</b> Insulation   Isolation   Isolamento		<b>TopShell 100</b>			<b>TopShell 130</b>
<b>Wärmeverlust</b> Heat losses   Pertesthermiques   Perdita di calore	kWh/24h	2.89	3.12	3.38	4.0
	W	121	130	141	167
<b>ErP-Klasse</b> ErP class   Classe ErP   Classe ErP		C	C	C	C
<b>Gewicht</b> Weight   Poids   Peso	kg	19	25	32	39
<b>Art.Nr.</b> 300112... Part no.   Réf.   Art.n.		0601	0801	1001	1502

Typ PBNRR/E		600		800		1000		1500	
Glattrohrwärmetauscher unten Bottom heating coil   Échangeurs de chaleur bas   Serpentino inferiore	m <sup>2</sup>	1.8		2.0		3.1		3.6	
Inhalt Glattrohrwärmetauscher Heating coil capacity   Contenance échangeurs de chaleur   Contenuto serpentinos de chaleur	l	11.8		13.3		20.5		23.3	
Glattrohrwärmetauscher oben Top heating coil   Échangeurs de chaleur haut   Serpentino superiore	m <sup>2</sup>	1.2		1.8		2.5		2.3	
Inhalt Glattrohrwärmetauscher Heating coil capacity   Contenance échangeurs de chaleur   Contenuto serpentinos de chaleur	l	8.1		11.8		16.2		15.1	
Puffertemperatur Buffer tank temperature   Température du ballon   Temperatura tampone	°C	55	80	55	80	55	80	55	80
Warmwasserdauerleistung Continuous output   Régime permanent   Potenza continua 10°C / 45°C / 80°C	l / h	138	354	172	443	172	443	184	473
max. Warmwasserdauerleistung max. hot water continuous output   Régime permanent max. eau chaude   Potenza continua max. acqua calda	kW	5.6	14.4	7.0	18.0	7.0	18.0	7.5	19.2

**Kombispeicher**  
**Combination storage tanks**  
**Ballon mixte**  
**Serbatoi di accumulo combinati**  
**PBNRR/E 600 – 1500**



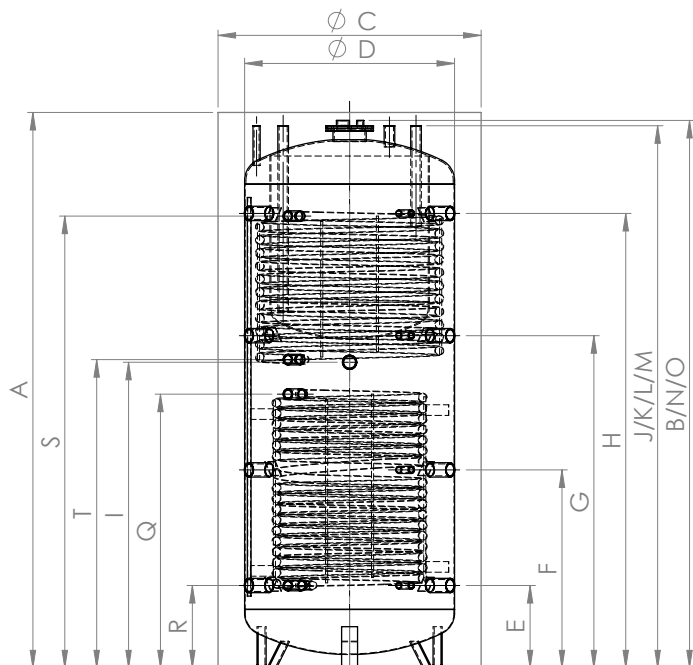



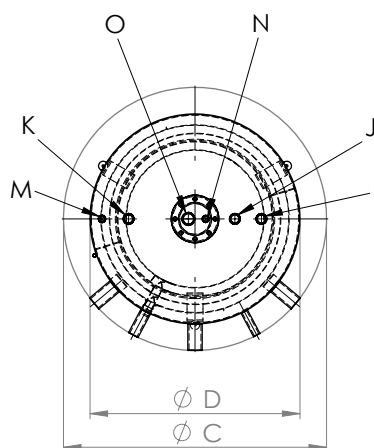











600 – 1500



600 – 1500



600 – 1500

	Verwendung Usage Utilisation Uso	Dimension Dimension Dimension Dimensione	600	800	1000	1500
B	Höhe ohne Isolierung Height without insulation   Hauteur sans isolation   Altezza senza isolaento	mm	1670	1705	2060	2175
D	Ø ohne Isolierung without insulation   sans isolation   senza isolamento	mm	700	790	790	1000
E	Anschluss 1 Connection   Raccord   Collegamento	 - mm	230	260	310	380
		G"	1 ½"	1 ½"	1 ½"	2"
		 - G"	½"	½"	½"	½"
F	Anschluss 2 Connection   Raccord   Collegamento	 - mm	610	630	745	825
		G"	1 ½"	1 ½"	1 ½"	2"
		 - G"	½"	½"	½"	½"
G	Anschluss 3 Connection   Raccord   Collegamento	 - mm	990	1030	1250	1350
		G"	1 ½"	1 ½"	1 ½"	2"
		 - G"	½"	½"	½"	½"
H	Anschluss 4 Connection   Raccord   Collegamento	 - mm	1380	1430	1710	1760
		G"	1 ½"	1 ½"	1 ½"	2"
		 - G"	½"	½"	½"	½"
I	Anschluss Mitte / ESH Connection middle SIH   Raccord milieu   Collegamento centrale	 - mm	850	800	1150	1250
		G"	1 ½"	1 ½"	1 ½"	1 ½"
J	Warmwasser Hot water   Eau chaude   Acqua calda	 - mm	1650	1685	2040	2155
		G"	1"	1"	1"	1"
K	Kaltwasser Cold water   Eau froide   Acqua fredda	 - mm	1650	1685	2040	2155
		G"	1"	1"	1"	1"
L	Zirkulation Circulation   Circulation   Circolazione	 - mm	1650	1685	2040	2155
		G"	1"	1"	1"	1"
M	Entlüftung Vent   Purge   Sfiato	 - mm	1650	1685	2040	2155
		G"	½"	½"	½"	½"
N	Fühler Brauchwasser Service water sensor   Sonde eau industrielle   Sensore acqua per uso domestico	 - mm	1670	1705	2060	2175
		G"	½"	½"	½"	½"
O	Magnesiumanode Magnesium anode   Anode de magnésium   Anodo in magnesio	 - mm	1670	1705	2060	2175
		G"	1 ¼"	1 ¼"	1 ¼"	1 ¼"
Q	VL Glattrohrwärmetauscher unten Bottom heating coil   Échangeurs de chaleur bas   Serpentino inferiore	 - mm	790	730	1030	1180
		G"	1"	1"	1"	1"
R	RL Glattrohrwärmetauscher unten Bottom heating coil   Échangeurs de chaleur bas   Serpentino inferiore	 - mm	250	260	310	380
		G"	1"	1"	1"	1"
S	VL Glattrohrwärmetauscher oben Top heating coil   Échangeurs de chaleur haut   Serpentino superiore	 - mm	1275	1430	1700	1760
		G"	1"	1"	1"	1"
T	RL Glattrohrwärmetauscher oben Top heating coil   Échangeurs de chaleur haut   Serpentino superiore	 - mm	920	1070	1160	1350
		G"	1"	1"	1"	1"